

## TMR3610

### Operators Manual



Digi-Star LLC  
W5527 Hwy 106  
Fort Atkinson, WI 53538  
USA  
Tel: 800-225-7695  
E-mail: sales@digistar.com

Digi-Star International  
Digi-Star Europe B.V.  
J.F. Kennedylaan 235  
NL-5981 WZ Panningen  
The Netherlands  
Tel: +31 (0)77 462 92 64  
E-Mail: dsinfo@digistar.com

## D4023-EN TMR3610 Operators Manual Rev B LAC

All rights reserved. Reproduction of any part of this manual in any form whatsoever without Digi-Star's express written permission is forbidden. The contents of this manual are subject to change without notice. All efforts have been made to assure the accuracy of the contents of this manual. However, should any errors be detected, Digi-Star would greatly appreciate being informed of them. The above notwithstanding, Digi-Star can assume no responsibility for errors in this manual or their consequence.

© Copyright 2016 Digi-Star Fort Atkinson (U.S.A.)

**Table of Contents**

**1.0 INTRODUCTION ..... 5**

**2.0 TMR3610 SPECIAL FEATURES ..... 6**

**3.0 ACCURACY STATEMENT ..... 7**

**4.0 TECHNICAL SPECIFICATIONS ..... 8**

**5.0 SAFETY DURING USE ..... 9**

**6.0 FEED MANAGEMENT SOFTWARE..... 10**

**7.0 INDICATOR OVERVIEW ..... 11**

**8.0 OPERATION ..... 13**

    8.1 Turn on Scale..... 13

    8.2 Zero Balance Indicator..... 13

    8.3 Tare and Net Gross ..... 14

    8.4 Print Key ..... 15

**9.0 DATA TRANSFER ..... 16**

    9.1 USB Drive Mode ..... 16

    9.2 RF Datalink Modes ..... 16

**10.0 INDICATOR DATA FORMATS ..... 17**

    10.1 Loading And Feeding Complete Loads Mode ..... 17

    10.2 Resize Recipe Weight..... 18

    10.3 Loading Recipe ..... 19

    10.4 Unloading to Pens..... 19

    10.5 Recipe and Pen List Mode ..... 20

    10.6 Loading Recipe ..... 21

    10.7 Unloading Pens..... 21

**11.0 ADVANCE COMMANDS ..... 22**

    11.1 Unload Partial Pens ..... 22

    11.2 Go Back to Skipped Ingredient ..... 22

    11.3 Change Feeding Number..... 23

    11.4 Clear Scale Memory..... 23

    11.5 Re-Use Recipe/Pen Data..... 24

    11.6 Mixer Time ..... 24

    11.7 Rotation Counter ..... 25

    11.8 Drive Ratio ..... 25

    11.9 Maintenance Message ..... 26

    11.10 Add a Pen to Pen List ..... 27

**12.0 COMMONLY USED DIRECT ACCESS NUMBERS (D.A.N.) ..... 28**

    12.1 Pre-Alarm..... 28

    12.2 Manual Pen Advance ..... 28

    12.3 Auto Ingredient Advance ..... 28

    12.4 Tolerance ..... 29

    12.5 Pen Tolerance..... 29

    12.6 Batch Advance Delay..... 29

    12.7 Scale ID or Truck ID..... 30

    12.8 Scale Number ..... 30

    12.9 Resize Option ..... 30

    12.10 Change Time ..... 31

    12.11 Change Date..... 31

---

<b>13.0 MANUAL PROGRAMMING OF RECIPES .....</b>	<b>32</b>
13.1 Switch to Manual Programming .....	32
13.2 Change Entry Method .....	32
13.3 Ingredient Re-name .....	33
13.4 Print Ingredients Names.....	33
13.5 Enter New Recipe .....	34
13.6 Edit Recipe.....	36
13.7 Erase a Recipe .....	37
13.8 Review a Recipe .....	38
13.9 Printing Single Recipe.....	38
13.10 Printing All Recipes.....	39
13.11 Loading a Recipe .....	39
13.12 Unloading to Pens.....	39
<b>14.0 OTHER FUNCTIONS .....</b>	<b>40</b>
14.1 Hold.....	40
14.2 Using Dimmer Option.....	40
<b>15.0 DIRECT ACCESS NUMBERS (D.A.N.) .....</b>	<b>41</b>
15.1 Options Changed by User.....	41
<b>16.0 INSTALLATION .....</b>	<b>55</b>
16.1 Indicator Mounting .....	55
16.2 Cable Connections.....	57
16.3 Connecting Load Cells in Junction Box.....	59
16.4 Load Cell Direction.....	59
<b>17.0 OPTIONAL EQUIPMENT .....</b>	<b>60</b>
17.1 Cab Controls (Wireless).....	60
17.2 Data Transfer Options.....	60
17.3 Transmitter/Receiver.....	60
17.4 Remote Indicators.....	61
17.5 Rotation Counter Sensor (Kit p/n: 408088) .....	61
<b>18.0 TROUBLESHOOTING .....</b>	<b>62</b>
<b>19.0 DECLARATION OF CONFORMITY.....</b>	<b>64</b>
<b>20.0 NOTES .....</b>	<b>65</b>

## **1.0 INTRODUCTION**

Thank you for your purchase of a Digi-Star TMR3610 scale indicator. Your TMR3610 is the culmination of more than 30 years of agricultural weighing engineering and expertise. With proper operation and preventative maintenance, the TMR3610 will last for many years.

The Digi-Star TMR3610 is primarily designed for weighing agricultural animal feed products during the loading and unloading of mobile and stationary feed mixers. The TMR3610 can also be used on feed delivery boxes, forage wagons, grain carts, and animal scales.

The TMR3610 is not for use with applications for which the TMR3610 is not intended, or as outlined in this manual.

Use of the TMR3610 outside of its intended purposes may result in inaccurate weight measurement or damage to instrument.

## **2.0 TMR3610 SPECIAL FEATURES**

### **Preset Weight**

The TMR3610 indicator provides simple to use and very useful Preset Weight feature. Using the numeric keypad the operator can enter the desired weight of product that the operator wants to load or unload. Once loading or unloading begins the TMR3610 will count down to 0 (zero). As the weight approaches 0 the audio and visual alarms will begin to pulse with the frequency of the pulses increasing the closer the preset weight gets to 0. At 0 the alarm light and buzzer will sound continuously.

See section 10.3 for details.

### **Rotation Counter / Timer**

The Rotation Counter / Timer provides the useful benefit of monitoring mix revolutions or mix time and a warning light, buzzer, or external signal will indicate when the desired mix revolutions or time has been achieved. For this the TMR3610 uses an optional Rotation Counter Sensor (See Option Equipment Section: 17.0) which is fitted to the drive line of the feed mixer. See section 11.7 for details.

### **Maintenance Message**

The Maintenance Message is available with the Machine Hour Meter function noted above and provides the ability for the equipment manufacturer or equipment owner to utilize the TMR3610 to display a specific Service or Maintenance message after a predetermined period of operation similar to a Change Oil message in an automobile.

See section 11.9 for details.

### **Machine Hour Meter**

The TMR3610 when fitted with the Rotation Counter Sensor can be configured to record hours of operation. The Machine Hour Meter can provide valuable information to aid the user in determining when maintenance and upkeep is required.

See section 11.6 for details

### **3.0 ACCURACY STATEMENT**

#### **READ THIS SECTION BEFORE USING THE SCALE SYSTEM**

Digi-Star Scale Systems are designed and manufactured to provide the greatest accuracy possible. However, proper installation and use are required in order to obtain the highest level of accuracy.

When using the scale system, the following must be considered in order to realize the best possible performance and accuracy.

- Load cells must be installed with the proper orientation. Most Digi-Star load cells have a label indicating either the “TOP” or bending direction of the load cell. Inspect load cells to determine if the load cells are installed correctly. Incorrect installation of load cells will result in inaccurate measurement.
- Load cells should not be subjected to any strains or loads other than the weight of the load. Stress or strain caused by misalignment or other factors when accurate weight readings are desired will negatively affect the accuracy.
- The weighing unit should be stationary with minimum movement, and on a level surface, to insure that weight readings are as accurate as possible.
  - The effect of movement on accuracy depends on the speed and roughness of the ground and application. Rougher terrain and faster and/or greater movement increases the degradation of accuracy.
  - A level surface is defined as being less than a 5” (13cm) change in rise over 10’ (3.0m) of run. As the slope of the terrain increases, degradation of accuracy will also increase.

## 4.0 TECHNICAL SPECIFICATIONS

<b>SIZE</b>	10.25" long x 8.0" high x 4" wide (260mm x 190mm x 105mm)
<b>WEIGHT</b>	4.5 lbs. (2.04 Kg)
<b>HELP MESSAGES</b>	Context sensitive help messages in 10 languages, Long messages are scrolled
<b>LOAD CELL EXCITATION</b>	8 volts D.C. Nominal, Capable of driving ten 350 Ohms transducers, Short circuit proof
<b>AUTO TEMPERATURE COMPENSATION</b>	Of internal circuitry for high accuracy weighing measurements
<b>LOAD CELL SIGNAL</b>	Compatible with Load Cells with greater than 0.25 mv/v
<b>CONNECTORS</b>	AMP plastic weather resistant circular connector. Gold plated contacts.
<b>POWER REQUIREMENTS</b>	10.5 to 16.0 V.D.C. 160 mA nominal with four 350Ω L.C.
<b>SET UP AND CALIBRATION</b>	Via front panel or saved when downloading the setting files.
<b>GROSS RANGE</b>	999,999 max-display
<b>LOW BATTERY WARNING POUND/KILOGRAM</b>	Enabled at 10.5V nominal Selectable
<b>DISPLAY</b>	6 Digit Chip On Glass LCD 1.7" high
<b>DISPLAY RESOLUTION</b>	.01, .02, .05, .1, .2, .5, 1, 2, 5, 10, 20, 50, 100
<b>DISPLAY UPDATE RATE</b>	Selectable: 1, 2, 3, 4 times/sec.
<b>MAX. DISPLAY RESOLUTION</b>	Adjustable to 40,000 counts max.
<b>ZERO TRACKING</b>	Selectable, On/Off
<b>SPAN ACCURACY</b>	$\pm(.1\% + .005\% / ^\circ\text{F})$ or $(.1\% + 0.009\% ^\circ\text{C})$ full scale $\pm 1$ output count
<b>MOTION DETECTION</b>	Selectable, On/Off
<b>ZERO ACCURACY</b>	$(.005\% / ^\circ\text{F})$ or $(0.009\% ^\circ\text{C})$ full scale $\pm 1$ output count for 0.5 mv/v transducer
<b>ENVIRONMENTAL ENCLOSURE</b>	IP65, IEC 529
<b>WEIGH ALGORITHM</b>	3 internally selectable digital filters to optimize performance (General, Slow, and Fast)
<b>HOLD MODE</b>	Used in mobile applications to stabilize displayed weight while moving the scale
<b>NON-VOLATILE MEMORY</b>	Standard
<b>OPERATING TEMP</b>	-29°C to 60°C    -20°F to 140°F
<b>2 REMOTE INPUTS (Power/Remote ports)</b>	Tare /Print / Hold / Net Gross / M+ / Zero / TR Hold / Re-enter Preset / Switch/ INGRED



## 5.0 SAFETY DURING USE



**Danger:** Indicates an imminently hazardous situation that, if not avoided, could result in death or very serious injury.



**Warning:** Indicates a potential hazardous situation that, if not avoided, may result in death or very serious injury.



**Caution:** Indicates a potential hazardous situation that, if not avoided, may result in a minor injury.

### NOTE!

**Cleaning:** Do not use running water, pressure washer or hoses to clean the indicator or touch screen.

**Charging Battery:** Disconnect all cables from the indicator and touch screen before charging the battery or welding on the machine. If cables are left connected, the indicator, touch screen and connected load cells could be damaged

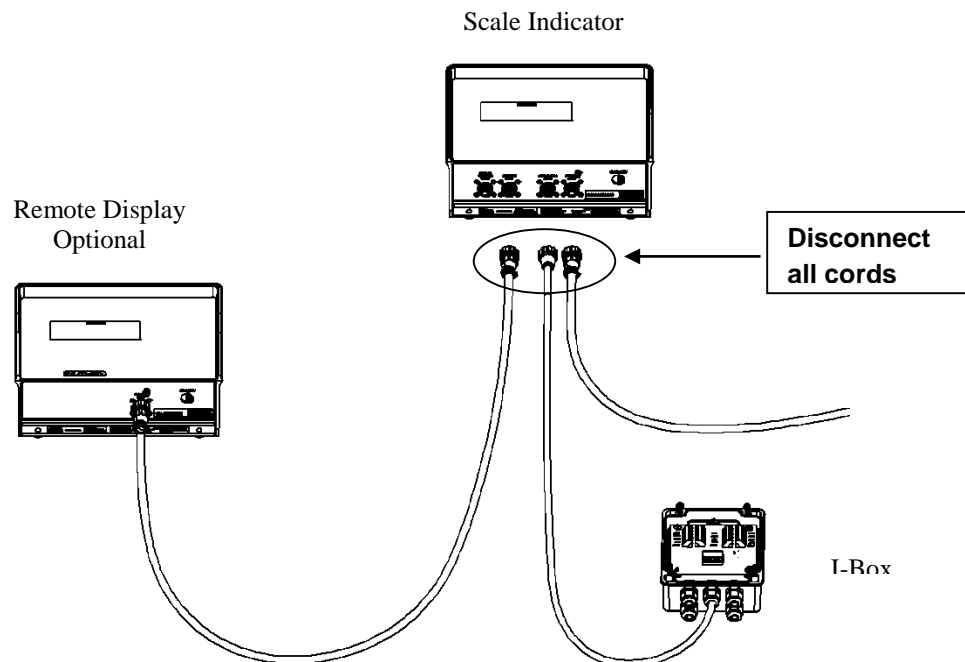

## 6.0 FEED MANAGEMENT SOFTWARE









# TMR Tracker™





TMR Tracker is a full-featured Windows based feed management system. TMR tracker also offers operators additional management tools including: Operator control, pen review, on line feed data exchange with nutritionists, ingredient tracking and numerous reports. TMR Tracker is an indispensable management tool for forward thinking operations.

For additional information go to [www.tmrtracker.com](http://www.tmrtracker.com)

## 7.0 INDICATOR OVERVIEW



- ①  - Press and hold for three seconds to zero balance.
- ② **Re-Alarm Light** - Starts flashing and alarm sounds when weight is within preset limit.
- ③  – Holds displayed weight when moving machine
- ④  – Mixing timer runs down, alarm sounds / Rotation counter is added to count shaft rotations, alarm sounds.
- ⑤  – Turns indicator on. Pressing while on will run self-test.
- ⑥  – Turns scale indicator off.
- ⑦ **Display Window** – Displays current actions.
- ⑧  – Press TARE button for temporary zero when adding more weight.
- ⑨  – Records to memory or prints displayed weight.
- ⑩  – Toggles between NET and GROSS weights.
- ⑪  – Selects recipes in memory

- ⑫ **ID** – Enter user’s ID number and feeding ID number when using the keypad.
- ⑬ **CLEAR** – Clear the characters on LCD (backspace)
- ⑭  – Press in list mode to begin pen unloading.
- ⑮  – Accepts change or proceeds to next item.
- ⑯ **Directional Arrows** – Moves through list of information. Left arrow (-) and right arrow (+)
- ⑰ **Keypad** – Input numbers or letters
- ⑱  **FUNCTION** – Performs tasks displayed when using the select button
- ⑲  **SELECT** – Display additional tasks for the user.
- ⑳  **HELP** – Shows additional information for last key pressed.

**Indicator Connections Overview**

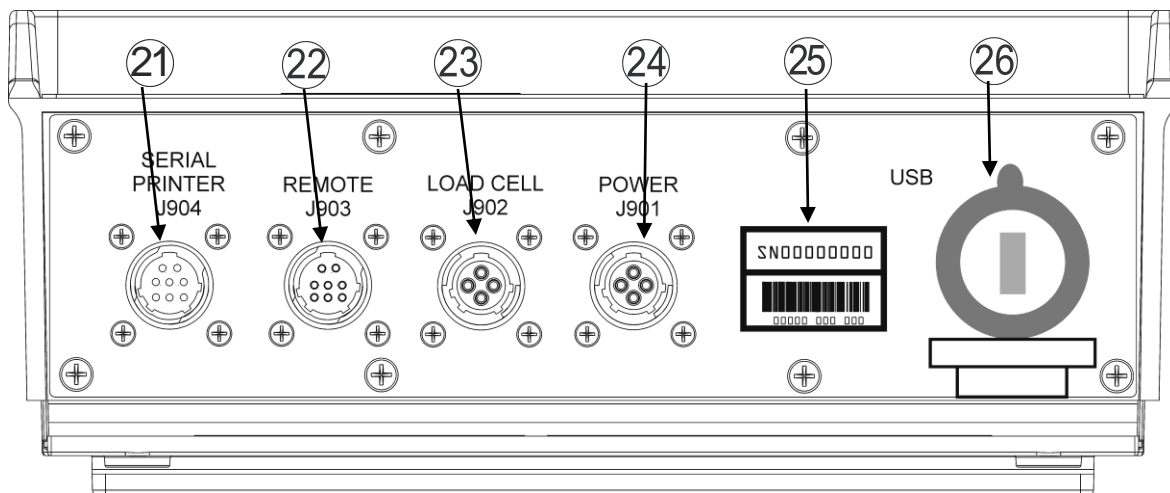

- ㉑ **Serial/Printer Port** – Communicate with computer and other digital input/output devices.
- ㉒ **Remote Port** – Optional remote display.
- ㉓ **Load Cell Port** – For J-Box Cord.
- ㉔ **Power Port** – For Power Cord.
- ㉕ **Serial Number Plate** – Serial Number of Indicator.
- ㉖ **USB Drive Port** – Insert USB Drive to upload/download data

## 8.0 OPERATION

### 8.1 Turn on Scale



1. Press .



1. Enter User ID Number if required.
2. Press .

### 8.2 Zero Balance Indicator



1. Press and hold  for three seconds to zero balance scale.
2. Flashing arrow on side of display points to gross next to the display window, scale is ready to weigh.

### 8.3 Tare and Net Gross

Tare is a temporary zero (Net Weight) to display total weight (Gross Weight, Press .



1. Weight displayed, Press  sets zero weight.



2. Display reads *ZERO* and flashing arrow on side of display points to NET.



3. Add more weight and display reads added weight value.





- To show total of original weight of 4000 pounds plus added 300 pounds, press  flashing arrow on side of display points to GROSS.



- Display reads *ZERO* and flashing arrow on side of display points to NET.

### 8.4 Print Key



- Press . Indicator sends data to printer or PC. Flashing arrow on side of display points to DATA.

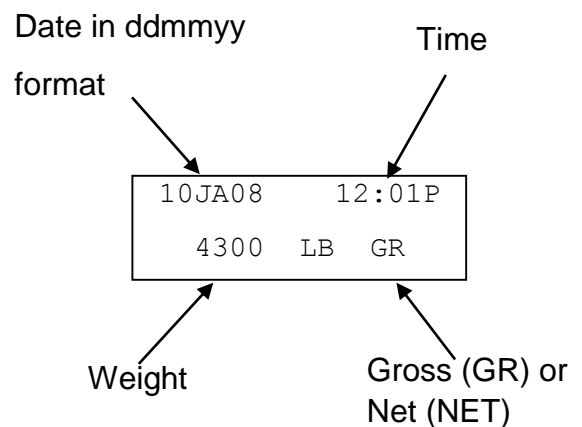

## 9.0 DATA TRANSFER



### 9.1 USB Drive Mode



#### To upload data:

Insert USB Drive.

1. Press  or .



Note: If indicator displays, Warning—unused recipes found in EZ—Press  to load new recipes from USB drive –Press  to exit.

Remove USB drive when complete.

#### To download data:

Insert USB Drive, indicator automatically sends data to USB Drive. Remove USB Drive.

### 9.2 RF Datalink Modes

Operation	Message
DataLink connects with indicator	←PC→
DataLink sends data to indicator	DL←IN
Indicator receives data	ALL FEED LINES RECEIVED -PRESS RECIPE KEY TO CONTINUE
Data complete, indicator sends data to DataLink	←PC→
Data sending	DL→OUT
To send data to PC if operator does not complete all feeding at end of feeding schedule. Press  until display shows message (right column), press  to perform transfer.	EZ→PC
The indicator marks uncompleted data as completed and sends feeding data to DataLink.	

**NOTE:** Indicator may also be manually programmed.



## 10.0 INDICATOR DATA FORMATS

Data sent to indicator sent in two formats:

**Complete Loads Mode:** Each load built by PC software. It assigns pens to recipe and builds exact load for pens.

**Recipe and Pen List Mode:** PC software sends recipe data and pen data in two different fields. Operator selects recipe to build and pen deliveries.

### 10.1 Loading And Feeding Complete Loads Mode

#### Starting a Recipe



1. Press .



1. Scrolls feeding number, first recipe and pen number.
2. Press UP and DOWN arrows to find desired recipe.
3. Desired recipe in display line, press .

## 10.2 Resize Recipe Weight

Indicator gives option to resize pen load weight.



1. Enter new weight or keep original weight.

2. Press .

**Note:** Press  to resize by number of head in pen.

**Note:** Press  to accept pen values without resizing.

**Note:** If indicator warns resized amount is over capacity, this may damage the mixer. To continue, press  to override.

### 10.3 Loading Recipe



1. First ingredient weight flashes in display. Load ingredient.
2. Weight approaches zero, alarm will flash and sound.
3. **Manual Advance:** Weight reached, press  again to start next ingredient.



**OR**

**Auto Advance:** When preset weight reached, indicator advances to next ingredient.

### 10.4 Unloading to Pens



Ingredients loaded, indicator displays first pen to unload.

1. **Manual Advance:** Press  to go to pen. When weight reached, press  to accept. Press  again to start next pen.

**OR**

**Auto Advance:** When preset weight reached, indicator advances to next pen. Last pen completed, indicator displays *RECIPE COMPLETE*.

**Note:** Do Not Press . (List Mode Only).



**Note:** If different pen needed press UP or DOWN arrows to find desired pen.

Press  for pen delivery.

## 10.5 Recipe and Pen List Mode

### Starting a Recipe





1. Press .
2. Display reads:  
Example:  
*RECIPE DRYCOW TOT-2500*
3. Press UP and DOWN arrows to select recipe,  to start.

### Resize Recipe Weight

Indicator will display: *RESIZE*, then resize weight.



1. Enter desired recipe weight using key pad.
2. Press , indicator resizes ingredients to recipe's total weight and displays first Ingredient to load.

**Note:** Indicator warns resized amount over capacity, press  to override.

## 10.6 Loading Recipe



1. First ingredient weight flashes in display. Begin loading ingredient.
2. Weight reached, alarm will flash and sound.
3. **Manual Advance:** Weight reached, Press . Press again to start next ingredient.

**OR**

**Auto Advance:** When preset weight reached, indicator advances to next ingredient.

## 10.7 Unloading Pens



1. When ingredient loading complete, display reads *RECIPE COMPLETE*. Then press the key (or use D.A.N. 6217 to enable AUTOPEN)
2. Press UP or DOWN arrows to select desired pen.
3. Press .
4. Pen and weight displayed, begin unloading to the pens.
5. **Manual Advance:** Weight reached, press . Press again to start next pen.

**OR**

**Auto Advance:** When preset weight reached, indicator advances to next pen.

6. When unloading is complete press to start next recipe.

## 11.0 ADVANCE COMMANDS

### 11.1 Unload Partial Pens



1. Press DOWN arrow to advance to next pen without finishing current pen.

**Note:** If pen tolerance is set and feeding stopped before preset weight reached, alarm sounds, Indicator displays: *PEN UNDERFED - PRESS PRINT TO REMOVE PEN FROM LIST - PRESS ON TO KEEP PEN,*

For Pen Tolerance; D.A.N. 6223 PENCHK

### 11.2 Go Back to Skipped Ingredient



1. Press UP or DOWN arrows to move back.

2. Press .

**Note:** Ingredient weight changed more than 4 display counts cannot restart that ingredient. For feature used to control skipped ingredient, use D.A.N. 6011 ISTART.

**Example:** If minimum display change is 10 lbs./kg---More than 40 lbs. Cannot restart that ingredient. One count is equal To 10 lbs./Kg.



### 11.3 Change Feeding Number



1. Press **ID** .
2. Enter user number.
3. Press **→**.
4. Enter feeding number (1-9).
5. Press **→**.

### 11.4 Clear Scale Memory



1. To clear scale memory enter D.A.N. 8201
2. Press **SELECT**. Message will be displayed;  
*ON= CLEAR, CLEAR= REUSE, NET= EXIT*
3. Press **ON** to erase feeding memory.
4. Press **CLEAR** to reuse feeding.
5. Press **NET GROSS** to exit

### 11.5 Re-Use Recipe/Pen Data



1. To re-use recipe/pen data enter D.A.N. 8201, then press .

*ON= CLEAR, CLEAR= REUSE, NET= EXIT*

2. Press  to reuse recipe/pen data.

**Note:** When re-using data stored in indicator, it takes recipe and pen information and removes completed weights loaded or unloaded and marks them undone. It will accumulate data day to day.





Download data to USB Drive before re-using recipe and pen data stored. **D.A.N. 6214**, ERASFD Feature will erase the DONE feed-lines, when info is downloaded to the USB.

**Note:** For continuous re-use, set D.A.N. **6205** to on.

### 11.6 Mixer Time

The mix timer allows the operator to set a timer to alert the operator when the mixing is completed. This can be manually entered or entered as part of the recipe using the TMR TRACKER or other software package.





1. Press .
2. Use the numeric keypad to enter the amount of time.
3. Press .
4. The MixTimer will begin to count down. When it reaches zero the alarm light and buzzer will turn on.
5. Press  to enter the weighing mode.
6. Press the  or  key to re-enter the batching mode.







### 11.7 Rotation Counter

The rotational counter is used much like the timer. It allows the indicator to count the number of revolutions of a mixer shaft and notifies the operator when a set count is reached.

**Note:** First enter D.A.N. 4301, Press . Choose TIMER or COUNTER, by pressing . Then press .



1. Press .
2. Use the numeric keypad to enter the number of rotations.
3. Press .
4. The Rotation Counter will begin to count down. When the counter reaches zero the alarm light and buzzer will turn on.
5. Press  to enter the weighing mode.
6. Press the  or  key to re-enter the batching mode.

### 11.8 Drive Ratio

**Drive ratio value is:** number of turns seen by the sensor divided by the number of Mixer rotations.



1. Enter D.A.N. 4302
2. Press  to enter the drive ratio value. .
3. Press .

### 11.9 Maintenance Message

Message can be used to alert the user of maintenance needed to be done on the equipment. Rotation Counter Sensor Kit--(p/n: 408088) needed for this feature. For proper maintenance Schedule, refer to equipment operators manual(s).





1. Enter D.A.N. 8011
2. Press . The user may edit the maintenance message using keypad or upload via USB.
3. *MANTMG 1* is displayed on LCD, then edit maintenance message by using keypad.

Example: Pressing key pad “1” one time will show 1, pressing two times will show “A”, pressing three times will show “B”, pressing four times will show “C”.

**11.10 Add a Pen to Pen List**



(List Mode Only)

1. Enter pen name or number
2. Press .
3. Press .





1. Press UP or DOWN arrows to find desired recipe.
2. Press .



1. Enter amount to unload to pen.
2. Press .







1. Enter number of animals/pen.
  2. Press .
1. If zones are active display reads:  
*ENTER ZONE 0-9*
  2. Press .

## 12.0 COMMONLY USED DIRECT ACCESS NUMBERS (D.A.N.)

### 12.1 Pre-Alarm

Select weight or percentage method, enter value to activate early warning indicator reaching preset.





1. Enter **4001**
2. Press .
3. Press  again to change between *WEIGHT* and *PERCENT*.
4. Press .
5. Enter Pre-Alarm value.
6. Press .

### 12.2 Manual Pen Advance

Ingredients automatically advance, Pens manually advance.



1. Enter **6009**
2. Press .
3. Press , choose on/off.
4. Press .

### 12.3 Auto Ingredient Advance

Allows hands free operation of programmed recipes. When auto advance feature activated, indicator automatically advances to next ingredient once tolerance, and delay time requirements met.

### 12.4 Tolerance

Sets weight “window” to accept loaded weight before auto advance.



1. Enter **6003**
2. Press . Press again to choose desired percentage off, or any entered using the keypad.
3. Press .

**Note:** OFF setting always advances after ingredient amount reached.

### 12.5 Pen Tolerance



1. Enter **6005**
2. Press . Press again to choose weight or percent
3. Press , screen will display *PENTOL*.
4. Enter weight or percentage desired.
5. Press .

### 12.6 Batch Advance Delay

Changes time indicator, waits before automatically advancing to next ingredient.



1. Enter **6008**
2. Press . Press again to select delay time or enter delay time using keypad.
3. Press .

**Note:** Set to Manual prevents automatic advance.



### 12.7 Scale ID or Truck ID

Each indicator has scale ID.



1. Enter **1003**
2. Press
3. Press and hold for three seconds to erase old ID, enter the new ID.
4. Press

**Note:** TMR Tracker or other 3<sup>rd</sup> party Software ID must match.

### 12.8 Scale Number

Used with cab control option.



1. Enter **2002**
2. Press . Press again to move up the list
3. Press to move down the list.
4. Press

**Note:** Do not use same number for two different Indicators.

### 12.9 Resize Option



Make weight changes to pens, unload weight or recipe load size.



1. Enter **6014**
2. Press . Press again to change to ON/OFF.
3. Press

**12.10 Change Time**



1. Enter **1202**
2. Press .
3. Press LEFT arrow to move cursor
4. Press UP arrow to set time.
5. Press .

**12.11 Change Date**



1. Enter **1204** and press .
2. Press LEFT arrow to move cursor. Format DDMMYY, Press UP arrow to set date.
3. Press .

### 13.0 MANUAL PROGRAMMING OF RECIPES

Three different **Entry Methods** for entering ingredients:

#### **Amount per Animal (this is the default setting)**

Allows entry of ingredient amounts required for feeding one animal. Indicator calculates preset amounts required for each ingredient.

#### **Percent (%) Per Load**



Enter ingredient amounts in (%). Indicator calculates amounts for each ingredient. Total of all ingredients must equal 100% in this mode.

#### **Amount per Load**

Allows entry of ingredient amounts required per load.

### 13.1 Switch to Manual Programming



1. Enter **6054**
2. Press .
3. Press  again to switch from *PC* to *SCALE*.

Select **PC** to program recipes with computer.

Select **SCALE** to manually program recipes with scale indicator.

4. Press .

### 13.2 Change Entry Method



1. Enter **6101**
2. Press .
3. Repeatedly press  scrolls. Select one of the following entry methods:

- 1 = Amount per Animal
- 2 = Percent (%) per Load
- 3 = Amount per Load

4. Press .



### 13.3 Ingredient Re-name

Ingredient names are listed in a standard table and can be changed using the following steps:

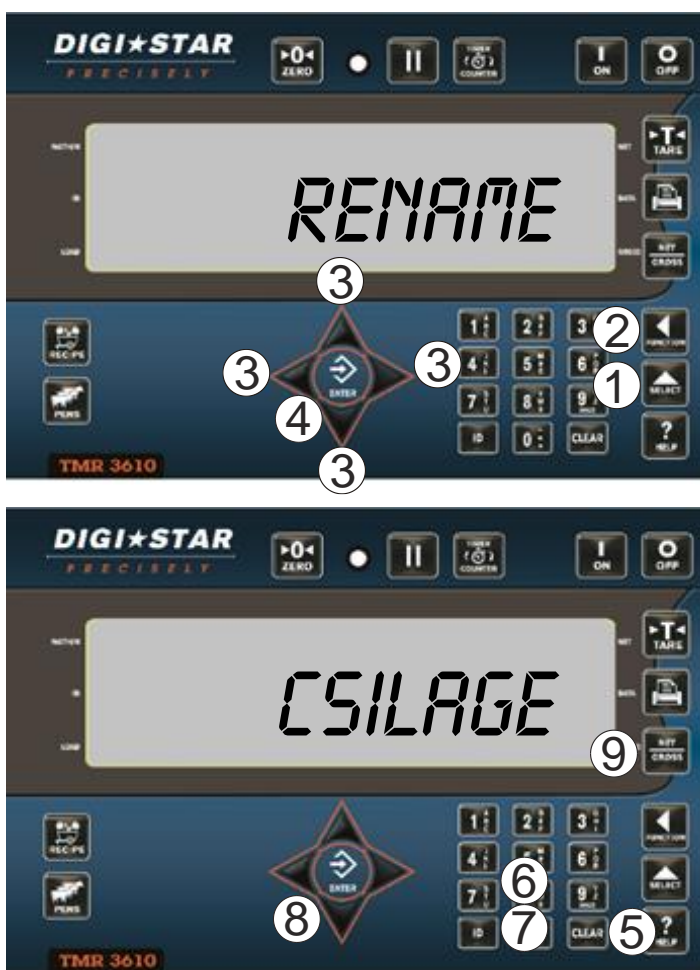

1. Repeatedly press until *RENAME* displays.
2. Press quickly and hold for three seconds.
3. Then first ingredient is shown. Use UP or DOWN arrows to select ingredients to edit. (Press RIGHT arrow to display pens. Press LEFT arrow to display ingredients)
4. Press again to edit ingredient. Display briefly shows *EDIT* and flashing cursor is displayed.
5. Press and hold , erases ingredient
6. Press “1” key once enters 1, twice enters A, three times for B, other numbers on keypads work the same.
7. Pause for one second after entering a number/letter and they shift to the left.
8. Press .
9. When done entering ingredients, press to exit.



### 13.4 Print Ingredients Names



1. Repeatedly press until *RENAME* is displayed.
2. Press quickly and hold for three seconds.
3. Press , prints total accumulations for ingredient displayed.
4. Press again prints accumulations for all currently used recipes.
5. Press again, prints names for all ingredients. Ingredients not used by recipe and shows unused.
6. When being printed, DATA will have a flashing arrow.

**13.5 Enter New Recipe**





1. Press and hold  until indicator beeps and displays *PROGRAM* then displays either first recipe programmed or *REC\_*.
2. This indicates recipe number can be entered using keypad.  
Example; *REC-01, REC-02, REC-03*
3. Press  to add recipe.



4. Press UP and DOWN arrows to scroll ingredients.





5. Press  to select ingredient shown on display.
6. Enter amount of ingredient required. (See note below)
7. Press  to store amount.



Repeat steps 4-7 for each ingredient Required.

**NOTE:** In percent/load entry mode a 75% ingredient, for example, should be entered As 75.00 on display. 5.75% ingredient entered as 5.75.





8. Press  to change pens.
9. Press  to scroll available pens.
10. Press  to select pen on screen.
11. Enter amount for pen.



12. Press  to store amount.
  13. Press  completes recipe.
  14. Indicator calculates and displays *TOTAL* amount of recipe.
- Repeat steps 1-14 until all recipes programmed.
15. Press  to exit.

**13.6 Edit Recipe**



1. Press and hold  until indicator beeps and displays *PROGRAM* .
2. Press UP or DOWN arrows until recipe number is displayed.
3. Press  to edit this recipe.
4. First ingredient name displayed followed by *AMOUNT*.



5. Enter new amount using keypad.
6. Press , stores and advances to next ingredient.

Repeat steps 5 and 6 for new amounts

7. Press DOWN or UP arrow until *DONE* is displayed
8. Press  to exit recipe being edited.

**NOTE:** Ingredients / Pens can now be added and removed from a programmed recipe.





9. Press UP arrow to return to previous ingredient.
10. Press and hold RIGHT arrow for three seconds to insert a new ingredient.

**NOTE:** This will insert the ingredient just before the current ingredient shown on display.









11. Press RIGHT arrow to display pens.  
Press LEFT arrow to display ingredients
12. Press UP or DOWN arrow to scroll available ingredients or pens.
13. Press  to select ingredient or pen.
14. Enter amount required.
15. Press  to store amount.



- To erase ingredient /pen:
16. Press and hold LEFT arrow to erase a feed-line. Message will ask to press the LEFT arrow to erase.
  17. Press LEFT arrow to erase the current ingredient or pen displayed on the screen.
  18. Repeatedly press  to finish editing.
  19. Indicator calculates and displays *TOTAL* amount of recipe.



### 13.7 Erase a Recipe



1. Press and hold  until indicator beeps and displays *PROGRAM* followed by first recipe number.
2. Repeatedly press  until desired recipe number displayed or keypad in recipe number and press .
3. Press and hold LEFT arrow, message scrolls: *PRESS PRINT TO PRINT RECIPE-  
PRESS MINUS TO ERASE RECIPE-PRESS  
NET/GROSS TO EXIT*
4. Press LEFT arrow to erase recipe.
5. Press  to exit.

### 13.8 Review a Recipe





1. Press .
2. Press UP and DOWN arrows to select recipe number.
3. Press LEFT or RIGHT arrow and scale indicator will automatically step through ingredients, then return to recipe number.
4. Press  or  to exit.

### 13.9 Printing Single Recipe

**Note:** Optional serial port must be installed for printing.



1. Press  displays first recipe. Repeatedly press  displays other recipes.
2. Press  prints recipe.
3. Press .

**13.10 Printing All Recipes**



1. Press  displays first recipe.
2. Press  recipe.
3. Press  again prints all recipes in memory.

**13.11 Loading a Recipe**



1. Repeatedly press  until recipe displayed.
2. Press  to accept recipe.

**13.12 Unloading to Pens**





1. Scale indicator displays recipe weight.
2. Begin unloading into a pen. As recipe unloads indicator displays recipe weight remaining.
3. Press  sets temporary zero if more than one pen gets same recipe.

## 14.0 OTHER FUNCTIONS

### 14.1 Hold

Hold mode prevents displayed weight from changing while moving mixer around.



1. Press .
2. Press  again, to return indicator to normal.
3. If weight is added while in hold mode press  to cancel hold.

**Note:** This feature is disabled on all legal for trade systems.

### 14.2 Using Dimmer Option









1. Repeatedly press  until dimmer is displayed.
2. Quickly press . Display back-light will dim.
3. Press  again to brighten display back-light.



## 15.0 DIRECT ACCESS NUMBERS (D.A.N.)

### 15.1 Options Changed by User

To display menus 1, 2, 3, 4, 5, 6 and Calibrate:

1. Repeatedly press  until MENU is displayed.
2. Press and hold .
3. Repeatedly press  to select Menus1, 2, 3, 4, 5, 6 or Calibrate.
4. Press  displays setting name and allows value changes.
5. Press either  or  to scroll through options for each setting/display.
6. Press  to save setting and next option for menu displays.

SETTING [display]	D.A.N. NO.	OPTIONS [displayed] BOLD=DEFAULT	DESCRIPTION
<b>MENU 1 – GENERAL SETTINGS</b>			
LANGUAGE (LANGAG)	1001	<b>English</b> <i>{ENGLISH}</i> Dutch <i>{NEDERL}</i> French <i>{FRANCS}</i> German <i>{DEUTSH}</i> Italian <i>{ITAL}</i> Portuguese <i>{PORT}</i> Spanish <i>{ESPAÑ}</i> Danish <i>{DANSK}</i> Hungarian <i>{MAGYAR}</i> Spanish <i>{VESTA}</i> Polish <i>{POLSKI}</i>	Select language to be displayed.
DISPLAY RATE (DRATE)	1002	1,2, <b>3</b> ,4,6,7,8,9,10	Update display times per second.
SCALE ID SETUP (SCALID)	1003	<b>NEW EZ</b>	Identity of scale location (truck id or Mixer number).
ZERO TRACK (ZTRACK)	1004	<b>ON/OFF</b>	If ON -zero track adjust balance for buildup of snow & mud.

SETTING [display]	D.A.N. NO.	OPTIONS [displayed] BOLD=DEFAULT	DESCRIPTION
WEIGH METHOD ( <i>W MTHD</i> )	1005	<b>1=General</b> 2=Fast 3=Slow	Select weigh method. The speed the weight changes as shown on the LCD.
1 PRESS ZERO ( <i>1 ZERO</i> )	1006	<b>ON/OFF</b>	If ON -press and hold Zero key to Zero/Balance scale.
AUTO OFF ( <i>AUTOFF</i> )	1007	<b>OFF</b> , 15, 30, 45, 60	Indicator turns off after selected minutes of stable weight.
DISPLAY UNIT ( <i>LB-KG</i> )	1008	<b>LB/KG</b>	Display pounds – LB or Kilograms - KG
SCROLL DELAY ( <i>SCROLL</i> )	1101	0,1,2,3, <b>4</b> , 5, 6, 7, 8, 9	Scroll rate for cold temperatures 0=normal 9=slowest
SAVE TARE ( <i>SAVTAR</i> )	1102	<b>ON/OFF</b>	Saves tare weight to non-volatile memory.
PRELOAD TARE ( <i>PRETAR</i> )	1103	<b>ON/OFF</b>	Tare weights can be entered using the numeric keypad.
TIME FORMAT ( <i>TIME F</i> )	1201	24 HR <b>AM/PM</b>	Select time format -AM/PM or 24 hours
TIME ( <i>TIME</i> )	1202	HH:MM:SS, AM/PM	Enter changes HH:MM:SS (use numeric keypad) use function key to change between HH:MM:SS then choose AM/PM.
DATE FORMAT ( <i>DATE F</i> )	1203	1-mm-dd 2-mm/dd/yy 3-mm/dd/yyyy 4-dd-mm 5-dd/mm/yy 6-dd/mm/yyyy <b>7-ddmmyy</b> 8-ddmmyyyy	Select date format
DATE ( <i>DATE</i> )	1204	Enter ddmmyy	Select key changes date or numerical keys -function key chooses DD/MM/YY.
DATE CHECK ( <i>DT CHK</i> )	1205	<b>ON/OFF</b>	Verifies the real time clock has a valid date at power up.
REMOTE INPUT 1 ( <i>RMINPT</i> )	1401	<b>MIXCTR</b> , INGRED, OFF, PRESET, SWITCH, TARE, PRINT, HOLD, NETGRS, M+, ZERO	Sets function of remote input line on the power cord.

SETTING [display]	D.A.N. NO.	OPTIONS [displayed] BOLD=DEFAULT	DESCRIPTION
REMOTE SWITCH MESSAGE (R1MSG)	1402		Message that is displayed for remote input switch condition.
REMOTE 1 SWITCH STATE (R1STAT)	1403	<b>OPEN/CLOSED</b>	Set remote input line state that displays message and/or illuminates alarm lamp. <b>D.A.N. 1401 set to "switch".</b>
REMOTE 1 SWITCH MESSAGE TIME (R1TIME)	1404	1...2-9	Set how often the remote switch message is displayed. Once every 1-9 seconds. <b>D.A.N. 1401 set to "switch".</b>
REMOTE INPUT 2 (RMINP2)	1411	TARE, <b>PRINT</b> , HOLD, NETGRS, M+, ZERO, TR HLD, OFF, PRESET, SWITCH	Sets function of remote input line on the remote port.
REMOTE 2 SWITCH MESSAGE (R2MSG)	1412	OPEN,--,+,*,0, 1,2,3, 4,5,6,7,8,9,A,B,C, D,E,F,G,H,I,J,K,L, M,N,O,P,Q,R,S,T,U, -V,-W,-X,-Y,-Z	Message that is displayed for remote input condition. <b>D.A.N. 1411 set to "switch".</b>
REMOTE 2 SWITCH STATE (R2STAT)	1413	<b>OPEN/CLOSED</b>	Set remote input line state that displays message and/or illuminates alarm lamp. <b>D.A.N. 1411 set to "switch".</b>
REMOTE 2 SWITCH MESSAGE TIME (R2TIME)	1414	0...2-9	Set how often the remote switch message is displayed. Once every 1-9 seconds. <b>D.A.N. 1411 set to "switch".</b>
PROGRAM ID (PRG ID)	1998	Example: 15FE16	Displays current software version
ESTIMATED WEIGHT (EST WT)	1999	Enter weight value using key pad. Then press enter.	Manually adjust Gross weight of scale by changing zero/balance. Press "on" to continue.
<b>MENU 2 – COMMUNICATIONS FEATURES</b>			
REMOTE (REMOTE)	2001	<b>ON/OFF</b>	If ON indicator communicates with Cab Control Display
SCALE NUMBER (SCL NO)	2002	1,2,3,4,5,6,7,8,9,10,11,12, 13,14,15,16,17,18,19,20, 21,22,23,24	Select scale number for cab control communication

SETTING [display]	D.A.N. NO.	OPTIONS [displayed] BOLD=DEFAULT	DESCRIPTION
EXTERNAL RADIO (EXTRAD)	2003	ON/OFF	Enables external radio to be connected to the J905 port.
DDL ATTACHED (DDL)	2004	YES/NO	Enables connection of a DDL (Data Down-Loader)
SCOREBOARD MODE (SCOREM)	2101	<b>0</b> ,1,2,3,4,5,6,7,8,11,12,15,27,37,38,39	Select scoreboard output
ZERO OUTPUT (ZEROUT)	2102	Weight displayed= Then press ZERO key and hold for three seconds.	Allows zero/balance for SCOREM #11 serial gross weight.
FRONT PANEL ZEROUT (ZEROFF)	2103	<b>OFF</b> /ON	Allows use of the zero key to zero/balance the serial gross weight.
OPERATION STATUS (OPSTAT)	2111	<b>0</b> , 2	Select operating data to be sent to a Remote Terminal
COM 1 BAUD RATE (C1 BD)	2201	1200,2400, 4800, <b>9600</b> , 14400, 19200, 38400, 57600, 115200	Sets baud rate for com port #1
COM 1 PARITY (C1 PA)	2202	NONE, ODD, <b>EVEN</b>	Sets parity for com port #1
COM 1 DATA BITS (C1 DATA)	2203	<b>7</b> , 8	Sets data bits for com port #1
COM 1 DELAY (C1 DLY)	2204	0, <b>.10</b> , .25, .50, .75, 1-5	Selects seconds to delay before advancing to next line.
COM 2 BAUD RATE (C2 BD)	2211	1200,2400, 4800, <b>9600</b> , 14400, 19200, 38400, 57600, 115200	Sets baud rate for com port #2
COM 2 PARITY (C2 PA)	2212	<b>NONE</b> , ODD, EVEN	Sets parity for com port #2
COM 2 DATA BITS (C2 DATA)	2213	<b>7</b> , 8	Sets data bits for com port #2
COM 2 DELAY (C2 DLY)	2214	0, <b>.10</b> , .25, .50, .75, 1-5	Selects seconds to delay before advancing to next line.
TARE AUTO PRINT (TAREAP)	2301	ON/OFF	If ON -tare auto-prints displayed weight.
ONE LINE PRINT (1L PRT)	2302	ON/OFF	If ON -indicator data prints on one line.

SETTING [display]	D.A.N. NO.	OPTIONS [displayed] BOLD=DEFAULT	DESCRIPTION
AUTO PRINT ( <i>APRINT</i> )	2303	ON/OFF	If ON -pressing keys auto-prints weight values.
PRINT FORMAT ( <i>PRTFMT</i> )	2304	<b>AUTO</b> , WTONLY, DOWNLD, DT+TM, ID+TM, IDWTTM, BATCH1, PRTAC1, PRTAC2, PRTAC3, PRWTRC, WTRCTM,3200-A, 3200-B, SCLABC,32-TMR, FDINFO, FEED-1	Select alternate & comma (CSV) formats.
PRINT ACCUMULATION ( <i>PRTACC</i> )	2305	0	Shows a running total of weights printed.
REMOTE DISPLAY ( <i>RDISP</i> )	2401	<b>EZ2</b> , EZ3MUX, COG, NONE	Select type of remote display
REMOTE TERMINAL ( <i>RMTERM</i> )	2402	ON/OFF	Sends display data to serial remote terminal interface
BAR GRAPH MODE ( <i>BARGRP</i> )	2411	OFF, <b>RIGHT</b> , LEFT, MIDOUT, MID IN	Selects output for a bar graph display when used with an RD4000 Remote Display
WEIGHT GRAPH ( <i>WTGRPH</i> )	2412	ON/OFF	Enables graph to be used with weight when used with a RD4000 Remote Display.
BAR WEIGHT ( <i>BAR WT</i> )	2413	<b>12000</b>	Enter the full scale gross weight for the bar graph display.
PRESET GRAPH ( <i>PRGRPH</i> )	2414	ON/OFF	Enables graph to be used with presets when used with an RD4000 Remote Display.
TIMER GRAPH ( <i>TMRGRPH</i> )	2415	ON/OFF	Enables graph to be used with timers when used with an RD4000 Remote Display.
<b>MENU 3 - MOTION &amp; WEIGHT</b>			
DISPLAY COUNT ( <i>COUNT</i> )	3001	.01,.02,.05,.1,.2,.5,1,2,5, <b>10</b> ,20, 50,100	Select display count size of weigh values.
CAPACITY ( <i>CAP</i> )	3002	<b>40,000</b>	Enter MAXIMUM weight measurable on scale.
WM1 ADJUST 1 ( <i>WMA1-1</i> )	3003	<b>10</b>	Increase this number to smooth weighing
WM1 ADJUST 2 ( <i>WMA1-2</i> )	3004	4	0=off. Use value less than WMA1-1 for quick response weight.

SETTING [display]	D.A.N. NO.	OPTIONS [displayed] BOLD=DEFAULT	DESCRIPTION
WM1 ADJUST 3 ( <i>WMR1-3</i> )	3005	<b>4000</b>	Enter the weight to active quick response weight Default-10% of scale capacity
WM2 ADJUST 1 ( <i>WMR2-1</i> )	3006	<b>30</b> , value must be less than 100 and more than 2.	Increase this number to smooth weighing
WM2 ADJUST 2 ( <i>WMR2-2</i> )	3007	<b>10</b> , value must be less than 100 and more than 0.	10=off. Use value less than WMA2-1 for quick response weight.
WM2 ADJUST 3 ( <i>WMR2-3</i> )	3008	<b>4000</b>	Enter the weight to active quick response weight Default-10% of scale capacity
MOTION ( <i>MOTION</i> )	3101	ON/OFF	ON = Motion arrow flashes with unstable weight. Prevents: Print, Zero, Tare, Advance
MOTION WEIGHT ( <i>MOT WT</i> )	3102	<b>0</b>	Enter weight used to detect motion. 0=Standard detection
<b>MENU 4 - PRESET, ALARM, and TIMER</b>			
PRE ALARM METHOD ( <i>P MTHD</i> )	4001	<b>WEIGHT, PERCENT</b>	Select weight or percentage method for pre-alarm
PRE-ALARM ( <i>P-ALM</i> )	4002	<b>100</b>	Enter a value to activate an early warning that indicator is reaching the preset.
ALARM OUTPUT ( <i>AL OUT</i> )	4003	OFF, <b>PRESET</b> , TR	Select preset or TR to control relay, horn & lamp.
BUZZER ( <i>BUZZER</i> )	4004	OFF, <b>ON</b> , 1-10	ALARM BUZZER -allows user to turn off alarm horn when loading/unloading
RELAY ( <i>RELAY</i> )	4005	OFF, <b>PRESET</b> , SETPNT	Selects the behavior of the +12VDC alarm output
PRESET DELAY ( <i>PRTDLY</i> )	4006	<b>10</b>	Set time to automatically advance/print entered preset
GROSS SET PNT OUTPUT ( <i>SETOUT</i> )	4101	<b>OVER/UNDER</b>	Select when the +12VDC Alarm Output becomes active.
GROSS SET POINT CHNG ( <i>SETCHG</i> )	4102	<b>500</b>	Set required weight change to turn off +12VDC Alarm Output.

SETTING [display]	D.A.N. NO.	OPTIONS [displayed] BOLD=DEFAULT	DESCRIPTION
GROSS SET POINT DELAY ( <i>SETDEL</i> )	4103	<b>0</b>	Set time delay before the +12VDC Alarm Output can Turn On/Off.
GROSS SET POINT ( <i>SETPNT</i> )	4104	<b>5000</b>	Set a gross weight in long form that will activate +12VDC Alarm Output on Power cord.
SET POINT COUNT ( <i>SETCTR</i> )	4105	<b>0</b>	Counts how many times set point is activated.
SET POINT WEIGHT SOURCE ( <i>STWTSC</i> )	4106	SERIAL/ <b>NORMAL</b>	Sets weight source for use with set point feature.
TOLERANCE METHOD ( <i>T MTHD</i> )	4201	<b>WEIGHT</b> , PERCENT	Select weight or percentage method for preset tolerance
TOLERANCE ( <i>TOLER</i> )	4202	<b>0</b>	Select tolerance weight percentage to accept preset.
TOLERANCE OVERLOCK ( <i>OVERLCK</i> )	4203	<b>OFF</b> /ON	Prevents auto-advancing if preset exceeds tolerance
TIMER, COUNTER ( <i>TMRCTR</i> )	4301	<b>TIMER</b> , COUNTER	Select time or mixer revolutions to decrement mix timer/counter.
DRIVE RATIO ( <i>DRATIO</i> )	4302	<b>1.00</b>	Enter the number of input pulses that equal 1 mixer revolution. REVCTR needs to be enabled in the setup options. <b>D.A.N. 4301 set to COUNTER.</b>
<b>MENU 5 - COM PORT SETUP</b>			
REMOTE DISPLAY PORT ( <i>RADPRT</i> )	5001	OFF, COM1, <b>COM2</b> , COM3	Sets serial remote display output
RADIO PORT ( <i>RADPRT</i> )	5002	OFF, COM1, COM2, <b>COM3</b>	Sets internal radio port
EXTERNAL RADIO PORT ( <i>EXRPRT</i> )	5003	OFF, COM1, <b>COM2</b> , COM3	Sets external radio port



SETTING [display]	D.A.N. NO.	OPTIONS [displayed] BOLD=DEFAULT	DESCRIPTION
PRINTER PORT ( <i>PRPORT</i> )	5005	OFF, COM1, COM2, COM3	Sets printer port
SCOREBOARD PORT ( <i>SCPRT</i> )	5006	OFF, <b>COM1</b> , COM2, COM3	Sets scoreboard port
OPSTAT PORT ( <i>OPSTAT</i> )	5007	OFF, <b>COM1</b> , COM2, COM3	Sets op-stat port
DDL PORT ( <i>DDLPR</i> )	5009	OFF, COM1, <b>COM2</b> , COM3	Sets DDL port
20MA MIRROR PORT ( <i>20MMR</i> )	5011	OFF, <b>COM1</b> , COM2, COM3	Sets port for 20MA signal to mirror
RECIPE PORT ( <i>RECPRT</i> )	5012	OFF, COM1, <b>COM2</b> , COM3	Sets recipe output port
DEBUG PORT ( <i>DBGPR</i> )	5999	<b>OFF</b> , COM1, COM2, COM3	Sets debugger port
<b>MENU 6.0 - APPLICATION SPECIFIC</b>			
BATCH PRE-ALARM METHOD ( <i>BPMTHD</i> )	6001	<b>WEIGHT</b> PERCENT	Select weight or percentage method for batch pre-alarm
BATCH PRE-ALARM ( <i>BP-ALM</i> )	6002	<b>100</b>	Enter value to activate an early warning that scale is reaching preset.
INGREDIENT TOLERANCE METHOD ( <i>ITMTHD</i> )	6003	<b>WEIGHT</b> PERCENT	Select weight or percentage method for ingredient tolerance.
INGREDIENT TOLERANCE ( <i>ITOLER</i> )	6004	<b>0</b>	Enter value to accept ingredient for auto advance.
PEN TOLERANCE METHOD ( <i>PTMTHD</i> )	6005	<b>WEIGHT</b> PERCENT	Select weight or percentage method for pen tolerance.

SETTING [display]	D.A.N. NO.	OPTIONS [displayed] BOLD=DEFAULT	DESCRIPTION
PEN TOLERANCE (PTOLER)	6006	<b>0</b>	Enter value to accept pen as completed.
BATCH TOLERANCE OVERLOCK (BOVRLK)	6007	<b>OFF</b> , ON	If ON – prevents auto-advancing if preset exceeds tolerance
BATCH ADVANCE DELAY (BDELAY)	6008	<b>0</b> , <b>MANUAL</b>	Select seconds to delay before advancing to next feed-line.
MANUAL PEN ADVANCE (MANPEN)	6009	<b>OFF</b> , ON	If ON -Overrides Automatic advance for Pens.
INGREDIENT STARTED WEIGHT (ISTART)	6011	<b>40 lbs.</b>	This weight threshold determines if the ingredient has been started.
PEN START WEIGHT (PSTART)	6012	<b>40 lbs.</b>	This weight threshold determines if the pen has been started.
PEN WEIGHT (PEN WT)	6013	<b>LOAD</b> , GROSS, NET	Select method for displaying pen weight - Net, Load, or Gross.
RESIZE RECIPE (RESIZE)	6014	<b>ON</b> , OFF	If ON - operator can change recipe size.
<b>MENU 6.0.5-COMMON BATCHING</b>			
RECIPE PRINT FORMAT (RECFMT)	6051	<b>SYSTEM</b> , AUTO, 32-TMR, FDINFO, FEED-1, SERMED	Defines how scale will print when in weighing mode or a batch.
RECIPE TOTAL (RECTOT)	6052	(SCALE)PROG, LAST, PRGCOR, LSTCOR—ON, <b>OFF(PC)</b>	Selects Total amount to be displayed when starting recipe. <b>D.A.N. 6054 select PC or SCALE</b>

SETTING [display]	D.A.N. NO.	OPTIONS [displayed] BOLD=DEFAULT	DESCRIPTION
INGREDIENT RE-SIZING ( <i>INGSIZ</i> )	6053	<b>(PC)OFF</b> , 1 ING, 1+2 ING,---- (SCALE) <b>OFF</b> , 1ING, 1 ING+P	Selects Automatic Ingredient Re-Sizing mode. <b>D.A.N. 6054 select PC or SCALE.</b>
PROGRAM RECIPE ( <i>PROGRAM</i> )	6054	<b>PC</b> , SCALE	Selects program method, PC or at SCALE.
<b>MENU 6.1- BATCHING</b>			
ENTERY METHOD ( <i>ENTHD</i> )	6101	1-amount/animal, 2-percent/load, <b>3-amount/load</b>	Select batching method. <b>D.A.N. 6054 must be set to "SCALE".</b>
DISPLAY SCOOP % ( <i>SCOOP %</i> )	6102	<b>OFF</b> , ON	If ON - displays scoop percentage to load. <b>D.A.N. 6054 must be set to "SCALE".</b>
INGREDIENT NAMES ( <i>INGRNM</i> )	6103	<b>ON</b> , OFF	If ON - displays ingredient names while batching. <b>D.A.N. 6054 must be set to "SCALE".</b>
ACCUMULATION ( <i>ACCUM</i> )	6104	<b>ON</b> , OFF	If ON – load/unload weights are accumulated while batching. <b>D.A.N. 6054 must be set to "SCALE".</b>
<b>MENU 6.2- 3610/4610 BATCHING</b>			
FORCE USER ID ( <i>USERID</i> )	6201	<b>OFF</b> , ON	If ON - operator MUST enter User ID to use scale.
RECIPE KEYS ( <i>RECKEY</i> )	6202	<b>OFF</b> , ON	If ON - disables certain keys when Loading / Unloading Recipe.
BATCH NUMBER ( <i>BATNUM</i> )	6203	<b>PCCTRL</b> , EZCTRL	Select either PC or EZ to control the batch number.

SETTING [display]	D.A.N. NO.	OPTIONS [displayed] BOLD=DEFAULT	DESCRIPTION
DOUBLE KEY ( <i>DBLKEY</i> )	6204	<b>OFF</b> , ON	Ignore extra INGR ADVANCE keys while feeding.
RECIPE REMAIN ACTIVE ( <i>RE-USE</i> )	6205	<b>OFF</b> , ON	Allows recipes to be RE-USED for another load.
RECIPE ENTRY METHOD ( <i>RENTRY</i> )	6206	<b>RECIPE</b> , BATCH#	Select recipe start method - recipe name or batch number.
SPLIT LOAD ( <i>SPLLOAD</i> )	6207	<b>OFF</b> , ON	If ON –Pen presets are re-calculated after each ingredient/pen.
START PRESET WEIGHT ( <i>STPRST</i> )	6208	<b>OFF</b> , ON	If ON –Return the starting preset in the timer/bunk read field of feed-line
SMALL INGREDIENT DISPLAY ( <i>SMINGR</i> )	6209	<b>0</b>	Enter value to display small ingredient message.
UNDONE RECIPES ( <i>UNDOM</i> )	6211	OFF, <b>ON</b>	If ON - displays all incomplete recipes.
DISPLAY RECIPE PENS ( <i>RECPEN</i> )	6212	<b>ON</b> , OFF	If ON - pens are displayed when selecting recipes.
POWER LOSS MESS ( <i>PWRLOS</i> )	6213		If ON - Display time & date of power loss if preset/recipe active.
ERASE DONE FEEDLINE ( <i>ERASFD</i> )	6214	<b>OFF</b> , ON	If ON -Erases done feed-lines after data transfer.
MEDIA STORAGE ( <i>MSTORE</i> )	6215	<b>QSTART</b> , MANUAL	Select MANUAL, AUTO or Quick START methods for transferring recipe information

SETTING [display]	D.A.N. NO.	OPTIONS [displayed] BOLD=DEFAULT	DESCRIPTION
RANGE TEST ( <i>R-TEST</i> )	6216	<b>OFF</b> , ON	If ON –Feed-lines sent from Data-Link are marked "done". <b>Valid when using Data-Link System.</b>
AUTO START PENS ( <i>AUTPEN</i> )	6217	<b>OFF</b> , ON	If ON -Starts Pens List after Recipe is loaded.
FEED ZONE ( <i>FDZONE</i> )	6218	<b>ALL</b> , 1, 2, 3, 4, 5, 6, 7, 8, 9	Select feed zone for recipe deliveries.
PARTIAL FEEDING ( <i>PARTFD</i> )	6219	<b>OFF</b> , ON	If ON –Partial feedings will be Recorded.
MIMIC TYREL ( <i>TC1300</i> )	6221	<b>OFF</b> , ON	If ON - Records preset weights like a Tyrel TCX-1300 Indicator.
SETUP FEATURES			
SIGNON SETTING ( <i>SIGNON</i> )	8001	<b>OFF</b> , ON	Enables continuous display of sign-on message
SIGNON MESSAGE ( <i>SIGMSG</i> )	8002	SIGMSG 1,2,3	Enables editing of the sign-on message
MAINTENANCE MESSAGE ( <i>MAINTMG</i> )	8011	MANTMG 1, 2, 3, 4, 5, 6, 7, 8, 9, 10	Enables editing of the maintenance message
MAINTENANCE MESS. TIME ( <i>MAINTTM</i> )	8012	<b>200</b> , Time is entered using key pad.	Time for maintenance message to be triggered.
DEAD WEIGHT CAL ( <i>WT CAL</i> )	8121	Follow instructions shown on LCD	Calibration method using weights
TEMPERATURE CALIBRATION ( <i>T CALB</i> )	8123	<b>OFF/ON</b>	On=Scale adjusts for temperature changes
INDICATOR SETUP INFO ( <i>DS&gt;SER</i> )	8299	<b>DS&gt;SER</b>	Downloads all setup information to the serial port
KEYTEST	8888		Enables front panel key test

SETTING [display]	D.A.N. NO.	OPTIONS [displayed] BOLD=DEFAULT	DESCRIPTION
<b>SETUP &amp; CALIBRATION</b>			
SETUP NUMBER ( <i>SETUP</i> )	8711	<b>146040</b>	Quick entry method selects weigh method 1-4lbs, 5-8 kg, gain 1-9, display counts 1-9 and capacity *1000
Calibration Number ( <i>CAL</i> )	8712	<b>32640</b>	Weight displayed at 0.4mV/V
SETTING (display)	D.A.N. NO.	OPTIONS (displayed) BOLD=DEFAULT	DESCRIPTION
<b>Enter the service menu is required to use the 9000 series numbers.</b>			
PRESET OPTION ENABLED ( <i>PRESET</i> )	90002	<b>PRESET, PREOFF</b>	Allows for entering a target NET weight.
RS232 OPTION ENABLE ( <i>RS-232</i> )	90003	<b>RS OFF, RS-232</b>	Enables/disables serial port
HOLD OPTION ENABLED ( <i>HOLD</i> )	90007	<b>HOLD, HLDOFF</b>	Enables the HOLD key functionality
MEMORY OPTION ENABLED ( <i>MEMORY</i> )	90008	<b>MEMERY, MEMOFF</b>	Enables/disables the M+, RM, CM options in the SELECT/FUNCTION key menu.
BLACK-OUT OPTION ENABLED ( <i>BLKOUT</i> )	90009		Enables functionality to restore the indicator to its previous state before power loss.
TIMER OPTION ENABLED ( <i>TIMER</i> )	90011	<b>TMR MX, TMROFF</b>	Allows countdown timer to be set using the TIMER key.
INTERNAL RADIO ENABLED ( <i>RADIO</i> )	90012	<b>RA OFF, RADIO</b>	Enables/disables radio—requires radio hardware
ROTATION COUNTER ( <i>REVCTR</i> )	90016	<b>REVCTR, REVOFF</b>	Enables/disables rotation counter

SETTING (display)	D.A.N. NO.	OPTIONS (displayed) <b>BOLD=DEFAULT</b>	DESCRIPTION
<b>Enter the service menu is required to use the 9000 series numbers.</b>			
NUMBER KEYPAD ENABLED ( <i>NUMKEY</i> )	90051	<b>NUMKEY</b> , NUMOFF	If ON—Enables front panel number pad
QWERTY KEYPAD ENABLED ( <i>QWERTY</i> )	90061	<b>QTYOFF</b> , QWERTY	If ON—Enables QWERTY style keyboard
MODEL IDENTIFICATION ( <i>MODELID</i> )	90201	<b>3610</b>	Allow entry of specific model ID to be display at power up.
MODEL ID TIME ( <i>MODLTM</i> )	90202	1, 2, 3, 4, 5, 6, 7, 8, 9, 0	If ON---Entry amount of time for MODEL ID to be display at power up.
CLEAR PEAK WEIGHT ( <i>CLRPKW</i> )	90302	<b>NO</b> / YES	If ON—Allows clearing of stored Peak weights
CLEAR ROTATION COUNTER ( <i>CLRREV</i> )	90303	<b>NO</b> / YES	Allow clearing of stored rotation counts
CLEAR HOUR METER ( <i>CLRHR5</i> )	90304	<b>NO</b> / YES	Allows clearing of hour meter
MAINTENANCE MESS. CLEAR ( <i>MANCLR</i> )	90305	<b>0</b>	Allows for clearing of maintenance message time or entry of new time.
REINITIALIZE ( <i>REINIT</i> )	99999	<b>NO</b> / YES	Reset indicator to factory default settings. 3
GAIN CALIBRATION ( <i>GM CAL</i> )	100001	<b>Starts Calibration Timer</b>	Enters gain calibration



## 16.0 INSTALLATION

### 16.1 Indicator Mounting

For most applications the equipment manufacturer provides the necessary mounting system and hardware, and mounts the Indicator for the End User.

Digi-Star provides a number of mounting options that allow the end user to customize the location and placement of the Indicator. The following section provides a list of the optional mounts.

In all cases the Digi-Star Indicator must be securely mounted to the equipment. Loose, or unsupported, Indicators can be damaged.

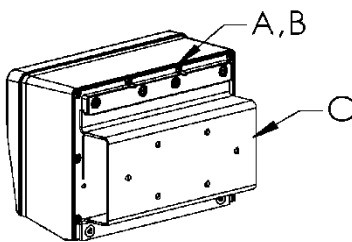

**STD UNIVERSAL  
MOUNT TALL**

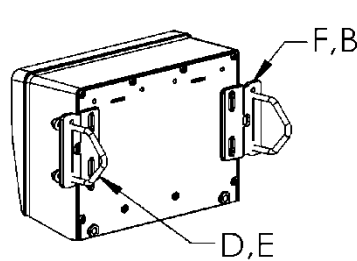

**WING NUT**

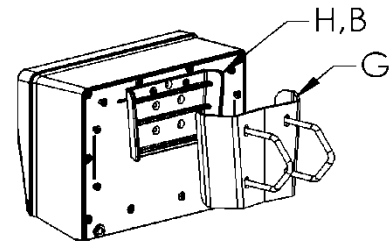

**WEDGE MOUNT**

KEY	PART NUMBER	DESCRIPTION
A	404353	BRACKET-EZ3 PLASTIC RAIL *
B	403780	SCR-#10 X 5/8 FHSTS BLACK ZP
C	840459	SUPPORT-HAT BRACKET
D	405069	U-BOLT 1/4-20 X 3.25 ZP
E	405084	NUT-1/4-20 TOP LOCKING FLANGE
F	403770	BRACKET- WING MOUNT *
G	405124	PACK-WEDGE MOUNT BRACKET WITH U-BOLTS & FLANGE NUTS
H	405244	EZ3 WEDGE MOUNT

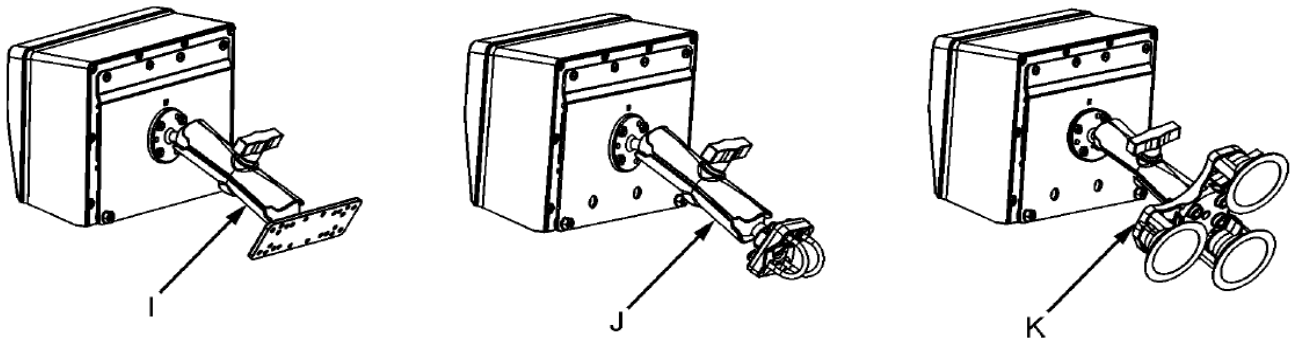

**RAM MOUNT**

KEY	PART NUMBER	DESCRIPTION
I	404799	KIT-1.5" RAM MOUNT WITH BOLT-ON BASE WITH HARDWARE
J	407544	KIT-1.5" RAM MOUNT WITH DUAL U-BOLTS (FITS 0.5"-1.5" ROUND)
K	407434	KIT-1.5" RAM MOUNT WITH TRIPLE SUCTION CUP BASE

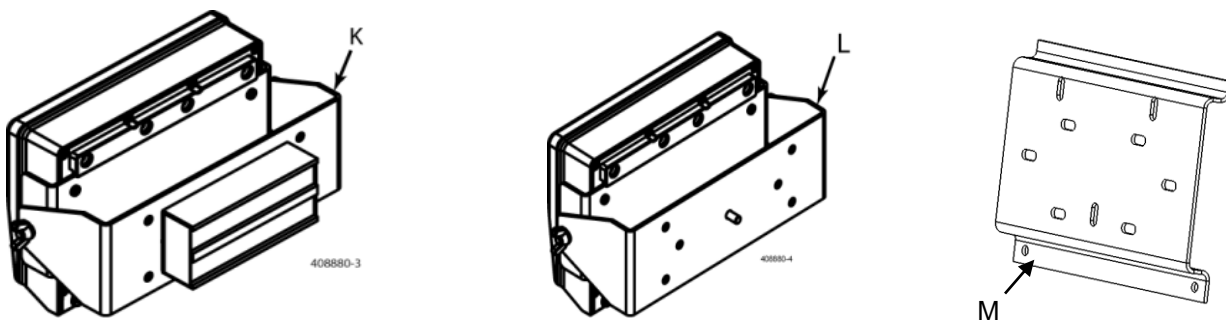

**SIDE & UNIVERSAL MOUNTS**

KEY	PART NUMBER	DESCRIPTION
K	408880	Mount for Large Indicators with hardware and magnet
L	408828	Mount for Large Indicators with hardware without magnet
M	408199	Universal mount short

## 16.2 Cable Connections

For accurate and reliable operation care should be taken when routing and connecting cables to the Digi-Star Indicator.

- Cables should be secured and protected from damage and abrasion.
- Long cables should not “hang” by the cable connector at the Indicator but should be secured to a structure close to the Indicator leaving a short “tail” to connect to the Indicator.

### Special Considerations for Power (+) and Ground (-):

- The Digi-Star Indicator is designed to operate at a continuous voltage ranging from 10.5 to 16.0 volts.
- Intermittent voltage drops to as low as 9.0 volts, such as when starting an engine, will be tolerated. Continuous low voltage will result in a Low Voltage warning on the display or the Indicator will power off.
- Voltage spike above 16 volts will damage the Indicator. Never weld or charge the battery on the equipment that the Indicator is mounted to without disconnecting the Indicator power cord. Never operate an Indicator on equipment with an engine charging circuit when the battery has been removed.

Digi-Star recommends that the red power (+) and black ground (-) are connected as follows:

- Power (+) can be either switched or keyed ON & OFF, or un-switched and always on.
- Power (+) and Ground (-) should come from a dedicated auxiliary power source when provided. When auxiliary power sources are not provided power should come from the main power distribution system.
  - Fuse or circuit protection of at least 5 amps, but no more than 10 amps, should be provided. Although the Indicator is protected internally by an internal fuse a fuse or circuit protection is required to protect the power cable and equipment.
  - Ground (-) connection should be made to a main ground (the battery ground (-) is often connected to this location). Do not use the chassis or frame of the equipment as a ground.

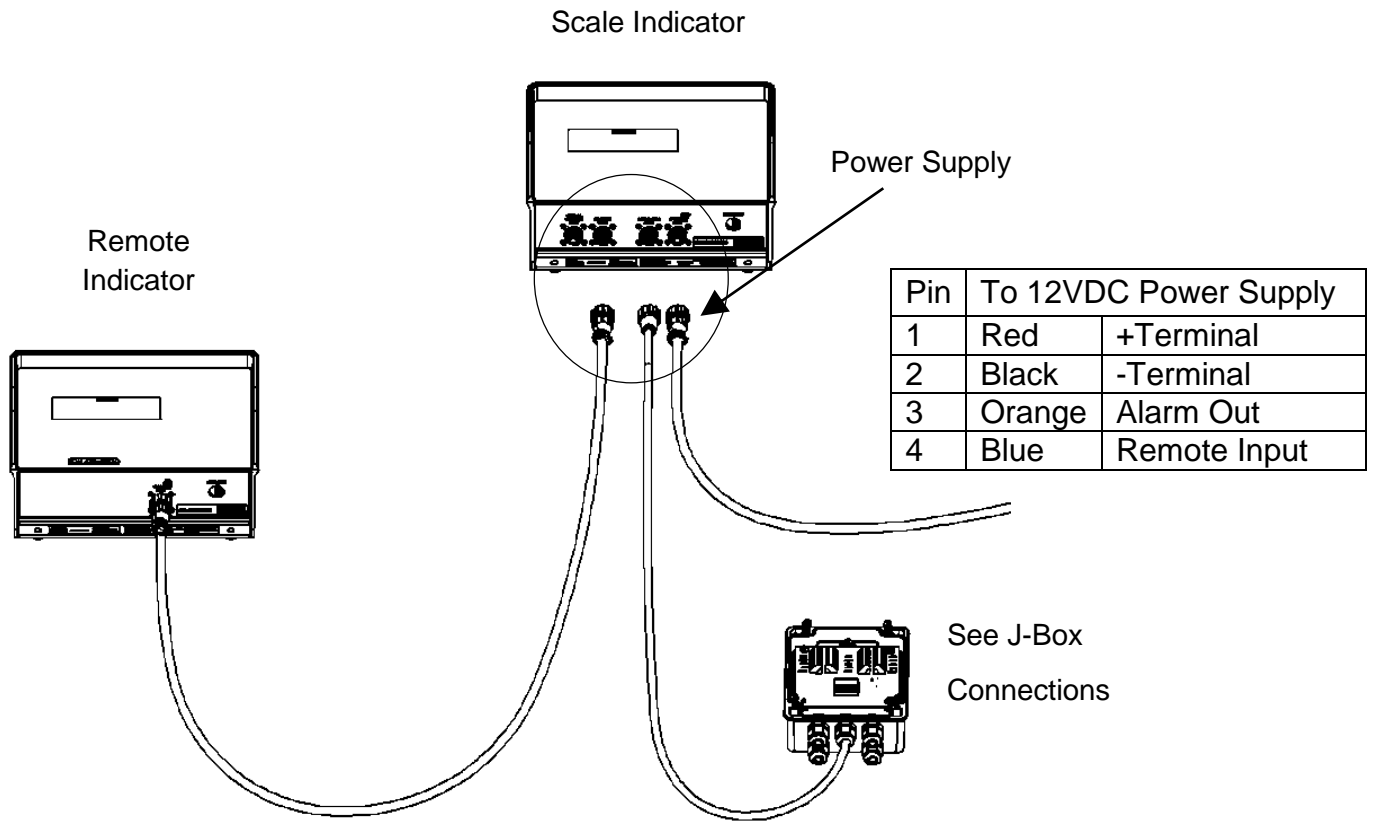

**Indicator Connection Diagram**

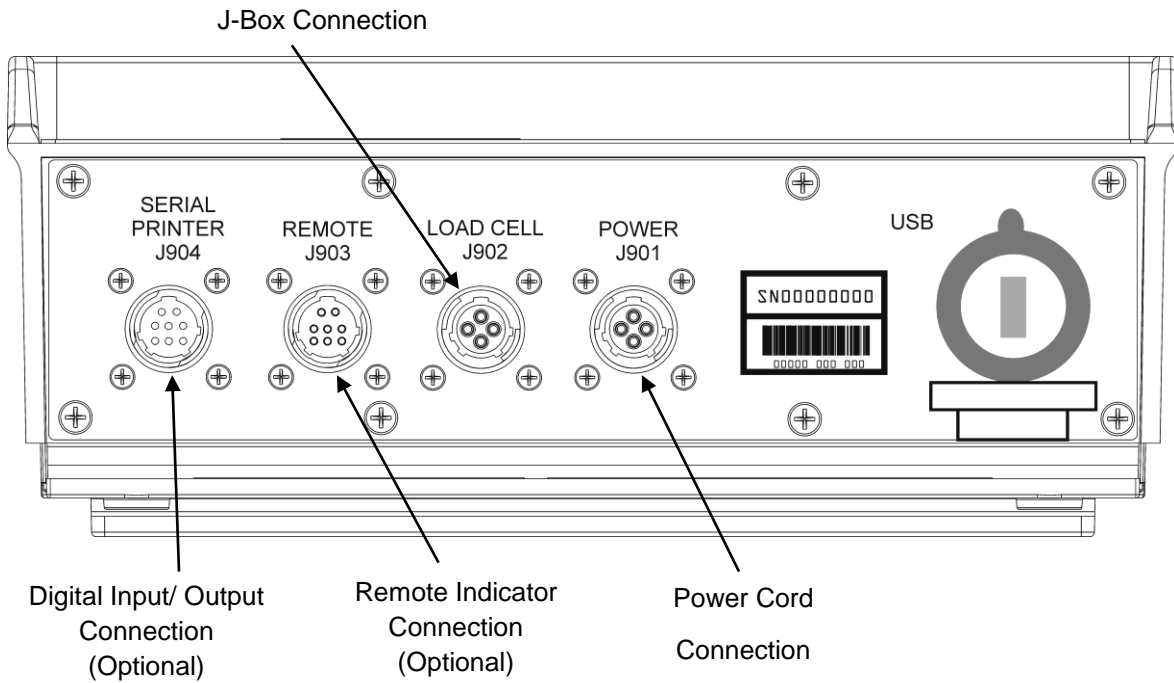

## Bottom Panel Cable Connections

### 16.3 Connecting Load Cells in Junction Box

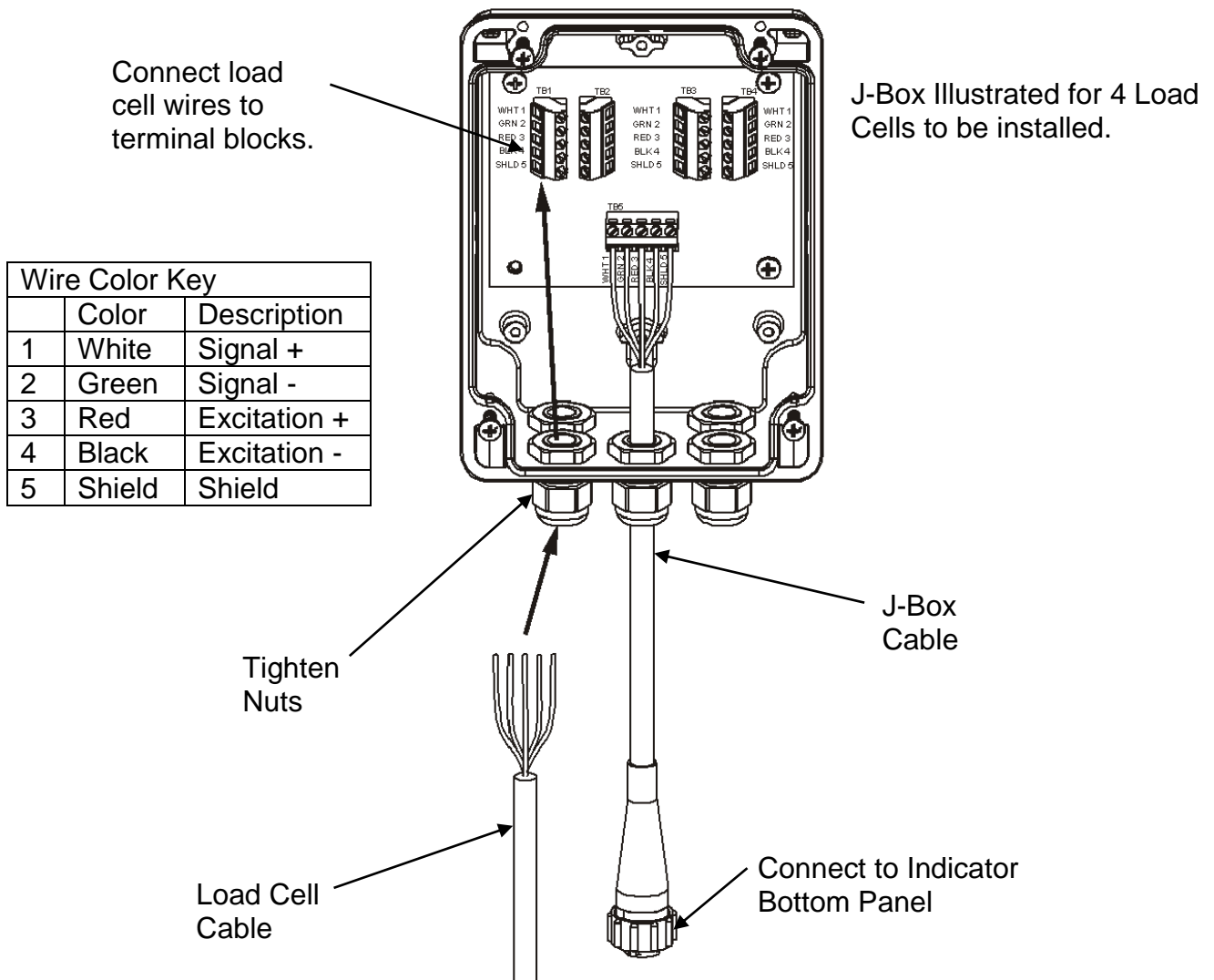

### 16.4 Load Cell Direction



Observe direction of arrow when installing load cell.

## 17.0 OPTIONAL EQUIPMENT

### 17.1 Cab Controls (Wireless)



#### Features

- Wireless remote with full key control of indicator on mixer
- Mount remote in easy view of loading
- Improves loading accuracy

#### Functions

- Communicates with multiple mixers

#### Specification

- Internally mounted 2.4 GHz radios
- Up to 1000 foot range
- 24 channels
- 12 or 24 volt DC system

### 17.2 Data Transfer Options



#### Kit Data Down Loader

Allows transfer of data from indicator to PC.

(Optional communication port must already be installed in indicator)

### 17.3 Transmitter/Receiver



Transmitter (shown) with factory installed receiver in indicator.

Use to zero indicator from a remote location.

Operating range about 90 feet.



**17.4 Remote Indicators**



- RD440 small remote display
- RD2400V backlit remote display with 1.7” high numbers
- RD2400V backlit remote display w/transmitter and installed receiver
- RD2400 backlit remote display with 1” high numbers
- RD2400 backlit remote display w/transmitter and installed receiver
- RD4000 remote display

**17.5 Rotation Counter Sensor (Kit p/n: 408088)**

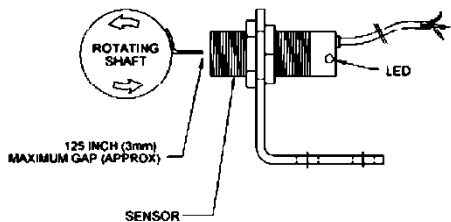

Use with EZ3610 indicator. Sensor allows operator to program indicator to count auger or PTO rotations for accurate mixing of feed. Also used for keeping maintenance log for equipment. Example; At 50 hours of operation time PTO shaft is scheduled for greasing or engine oil is scheduled for changing. **For proper equipment maintenance needed, refer to equipment operator manual.**

**18.0 TROUBLESHOOTING**

**FLOW CHART**

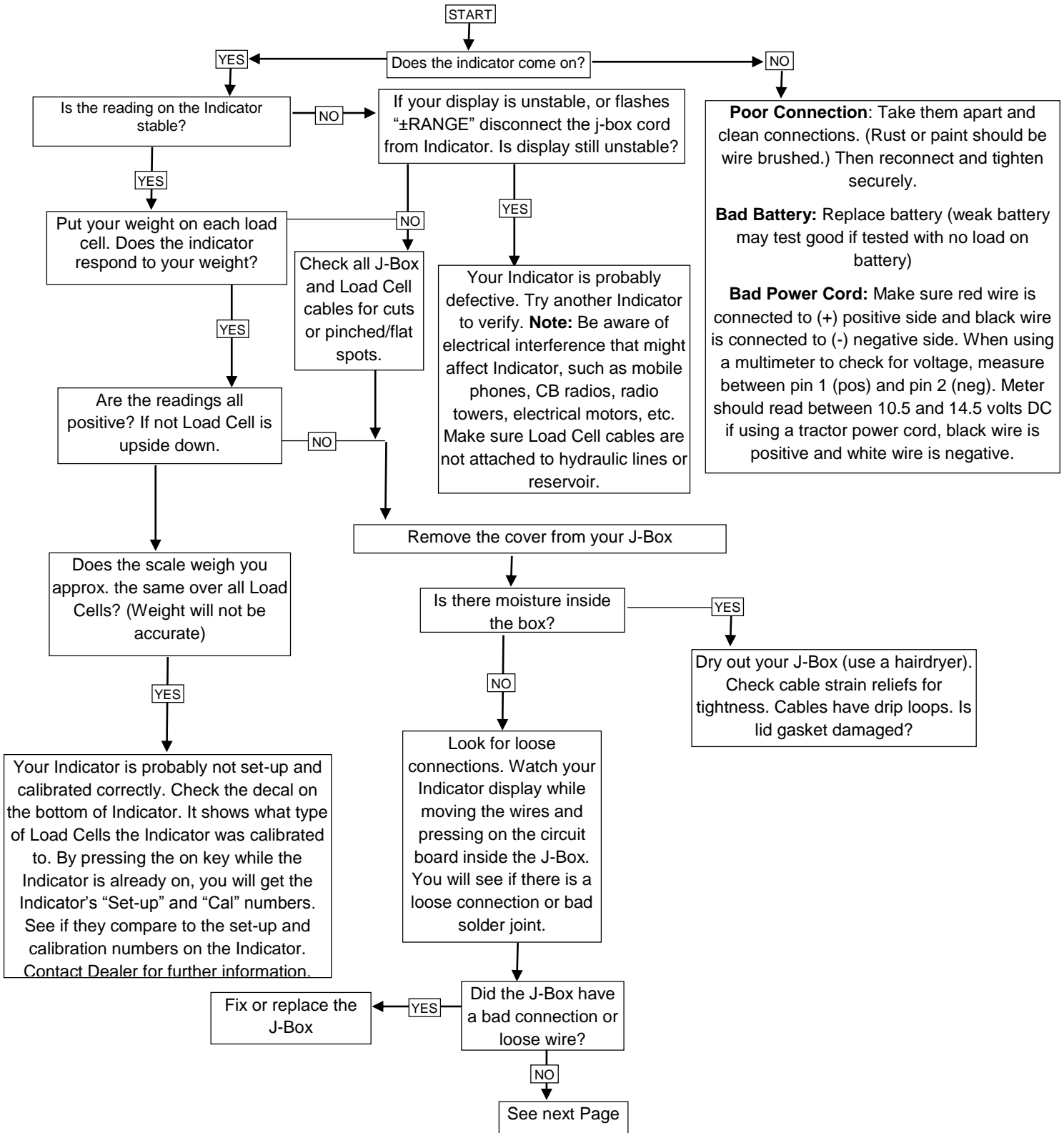

**FLOW CHART**

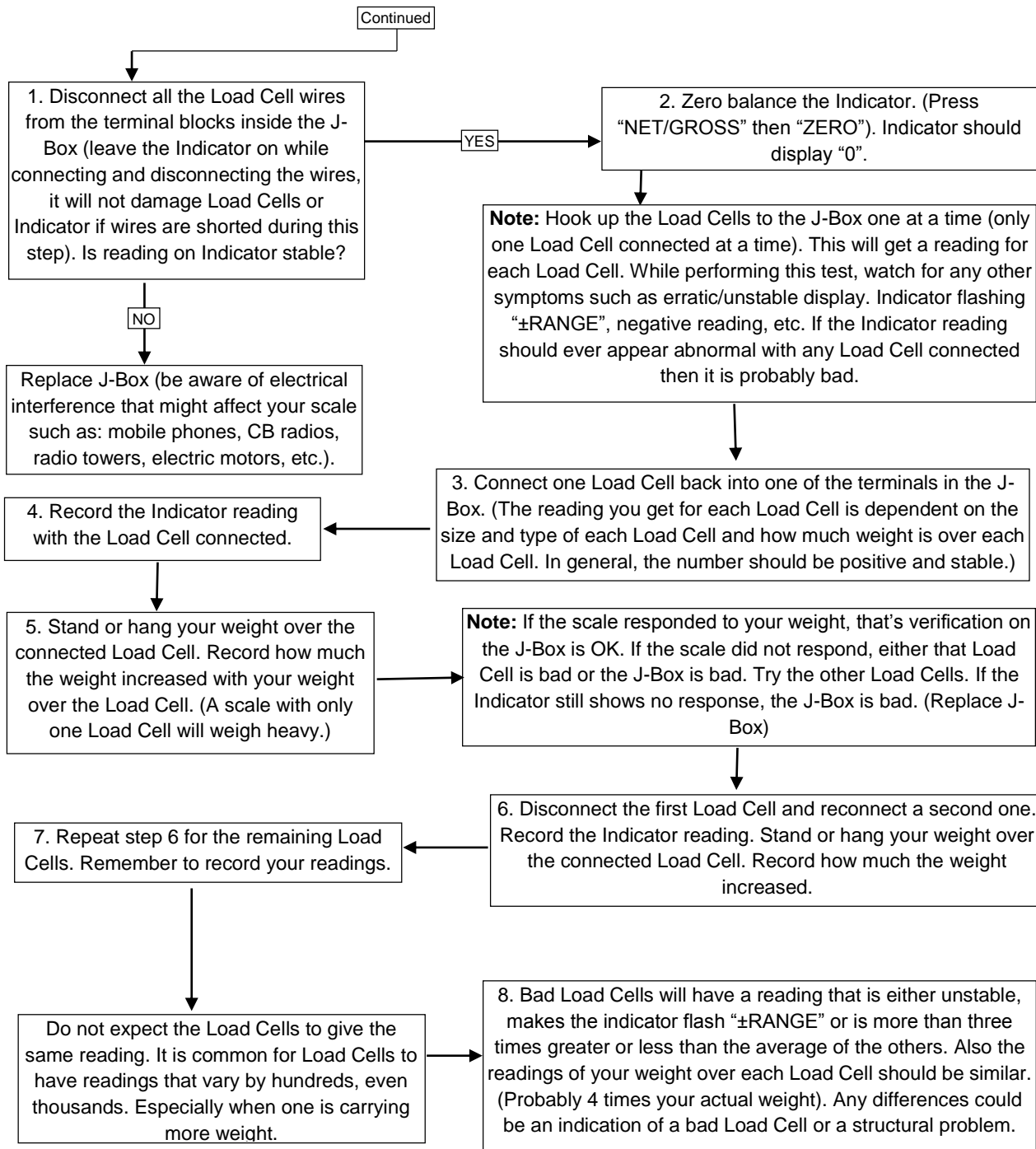

**19.0 DECLARATION OF CONFORMITY**

EMC DECLARATION OF CONFORMITY	
Application of Council Directive(s) <u>2004/108/EC</u>	
Manufacturer's Name:	Digi-Star, LLC
Manufacturer's Address:	W5527 State Hwy 106 Fort Atkinson, WI 53538
European Representative Name:	Digi-Star International
European Representative Address:	J.F. Kennedylaan 235 5981 WX Panningen The Netherlands
Model Name:	TMR3610, EZ2810
Conformance to:	<ul style="list-style-type: none"> <li>§ EN 61326-1 electrical equipment for measurement, control, and laboratory use (See Report Number 314363.)</li> <li>§ EN 55011, for Class B ISM equipment for industrial, scientific, and medical equipment. (See Report Number 314363.)</li> </ul>
Equipment Type/Environment:	Electronic weighing scale systems; not legal for trade. For agricultural, commercial and industrial use.
Beginning Serial No.:	00001001
Year of Manufacture:	2015
We, the undersigned, hereby declare that the equipment specified above conforms to the above Directive(s).	
<b>Manufacturer</b>	<b>Legal Representative in Europe</b>
	
Signature	Signature
Full Name: Steven Gorseth	Full Name: Wim de Wit
Position: Director of Engineering	Position: Managing Director
Place: Fort Atkinson, WI U.S.A.	Place: Panningen, The Netherlands
Date: Jan 23, 2015	Date: Jan 23, 2015

## **20.0 NOTES**